

ASCO Quality Training Program

Reducing Parkland Medical Oncology Infusion No-Show Rate

Radhika Kainthla, MD; Bryana Anderson, NP; Sarah Culver, LCSW; Amy Jones, MD
September 24, 2020

Institutional Overview

Parkland Health and Hospital System (PHHS)

- Established 1894 to provide indigent care for Dallas county residents
- Safety-net hospital and outpatient clinic system
 - Largest publically funded hospital in Texas
 - Charity care available regardless of citizenship/legal status
 - 1 million patient visits/year
 - Level 1 trauma center, regional burn center

PHHS Medical Oncology

- 5 disease-group clinics
- 21 faculty (through UT Southwestern), 18 fellows, 13 APPs, 1 LCSW
- 10,000 unique patients/year, 2200 new diagnoses
 - 95% socioeconomically disadvantaged
 - 55% uninsured, 22% Medicaid
 - 84% underserved minorities
- 50 chair infusion center
- Dedicated inpatient service



Team members

Project Sponsor: Umber Dickerson, MPH

Team Leader: Radhika Kainthla, MD

Team Members: Amy Jones, MD, Bryana Anderson APRN, FNP-C, Sarah Culver, LCSW, CCM

Additional Support: Charles Okpara, RN (Infusion Nurse Manager), Viridia Wallace (Senior Scheduler), and Neha Pandey, RN (Clinic Nurse Manager)

Coaches: Vedner Guerrier, MBA; Arpan Patel, MD

Problem Statement

PHHS Medical Oncology Infusion center has a 16.4% no-show rate of patients scheduled for infusions and injections in January 2020, resulting in dissatisfaction and wasted resources in a resource-limited system.

Baseline data summary

Item	Description
Measure:	Number of missed appointments in infusion center
Patient population:	Patients scheduled for infusions or injections in infusion center
Calculation methodology:	Documented no-shows divided by scheduled appointments
Data source:	Manual EPIC chart review
Data collection frequency:	Daily
Data limitations:	Lack of documentation of reason for no-showing

Outcome Measure

January No-Show Rate

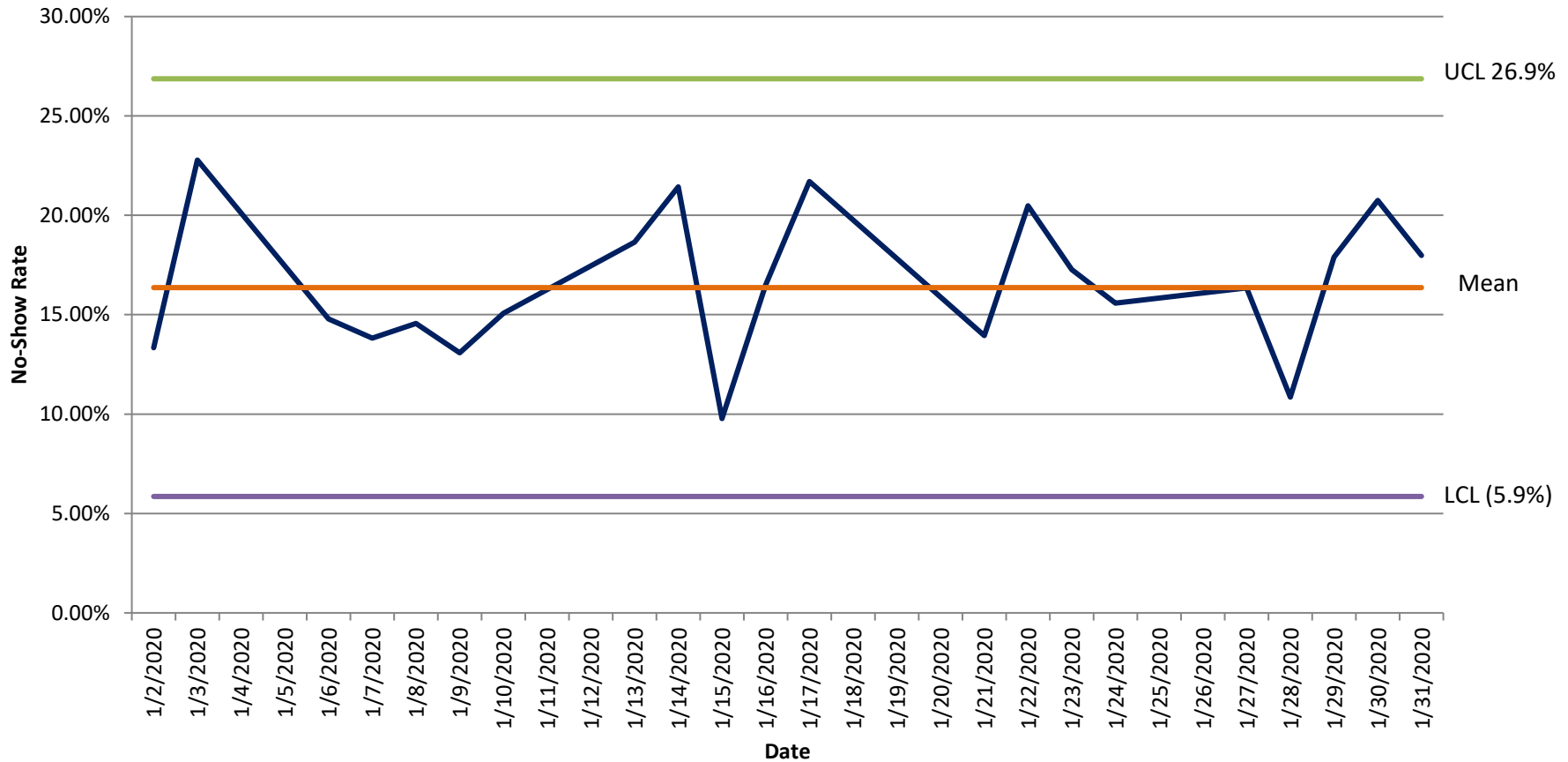

No-Show Reason – January Baseline

Reason for No-Show
(January 2020)

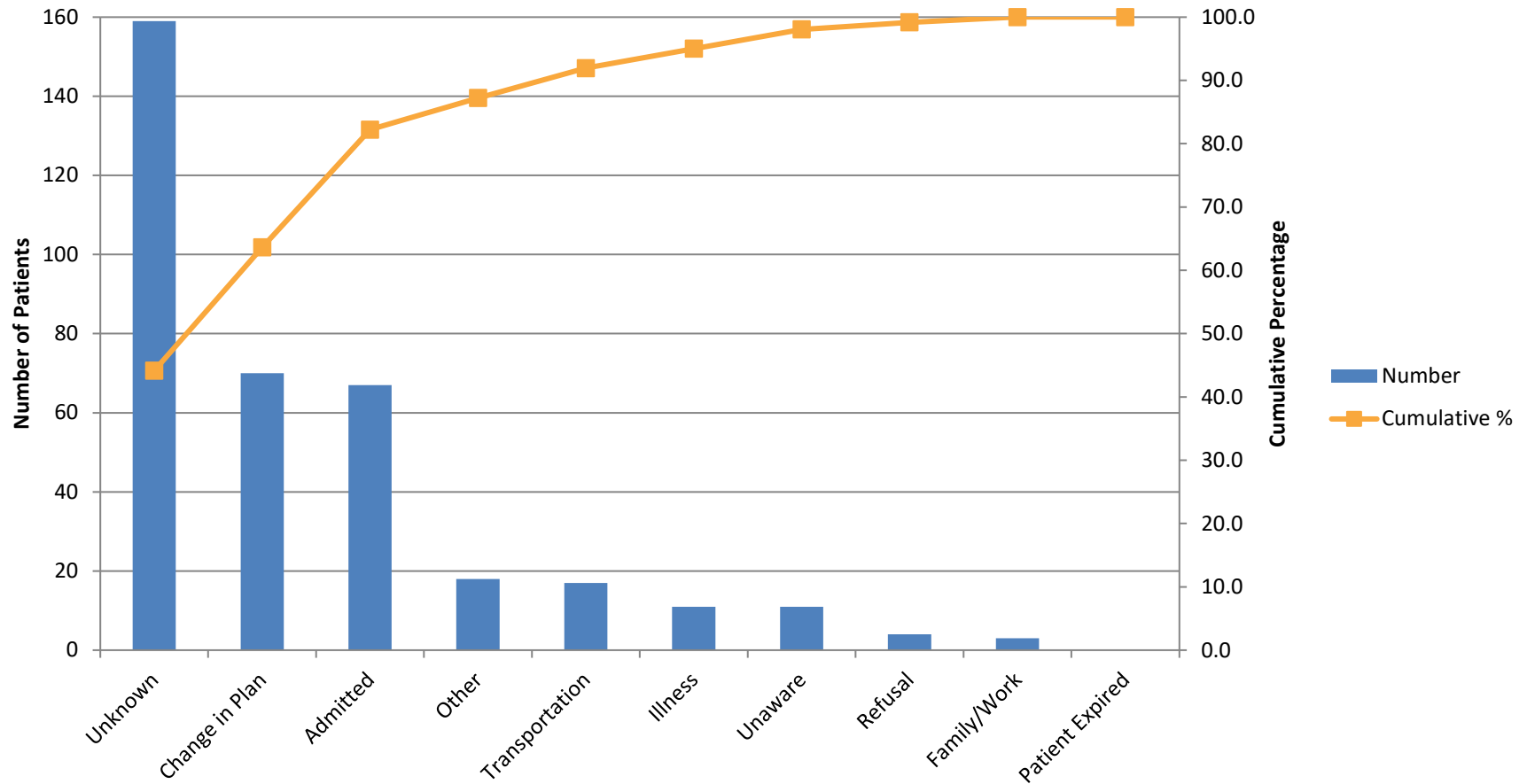

Aim Statement

Reduce the no-show rate by 33 percent for scheduled infusions and injections at the Parkland Oncology Infusion Center by September 1, 2020.

Process Map 1: Infusion Scheduling

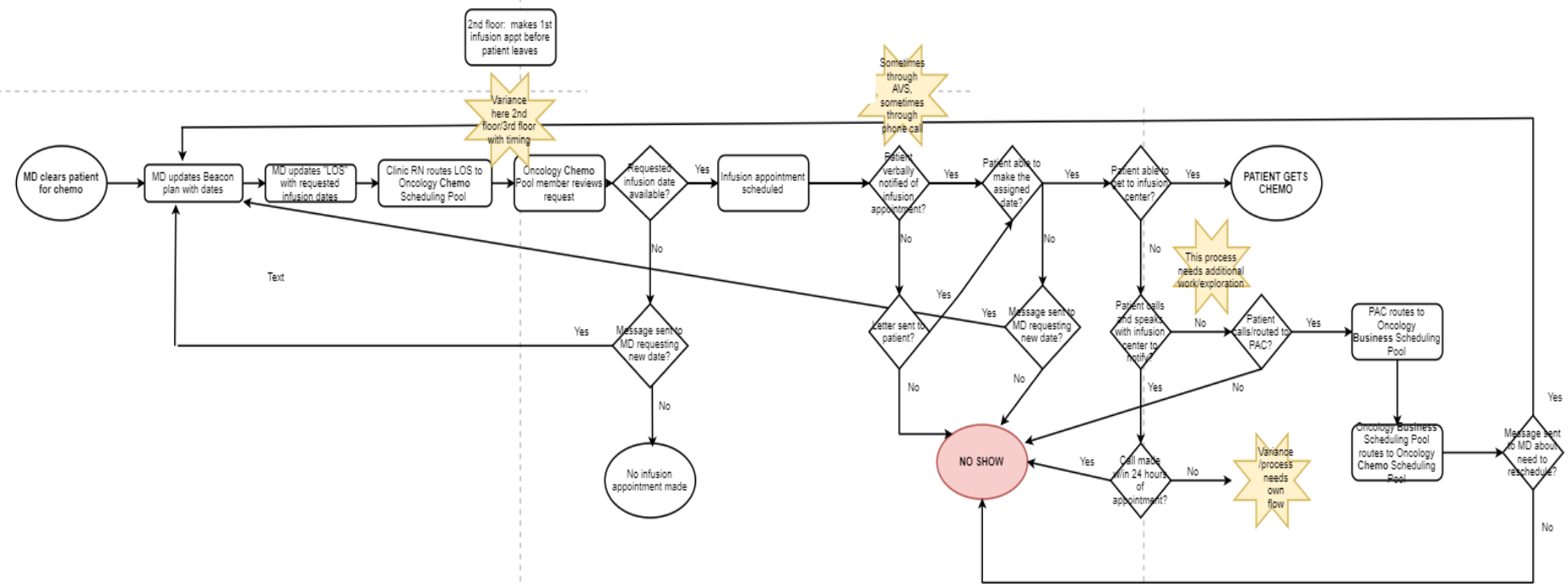

- Many points of variance
- No standard operating procedures across individuals and clinics

Process Map 2: Provider changes plan

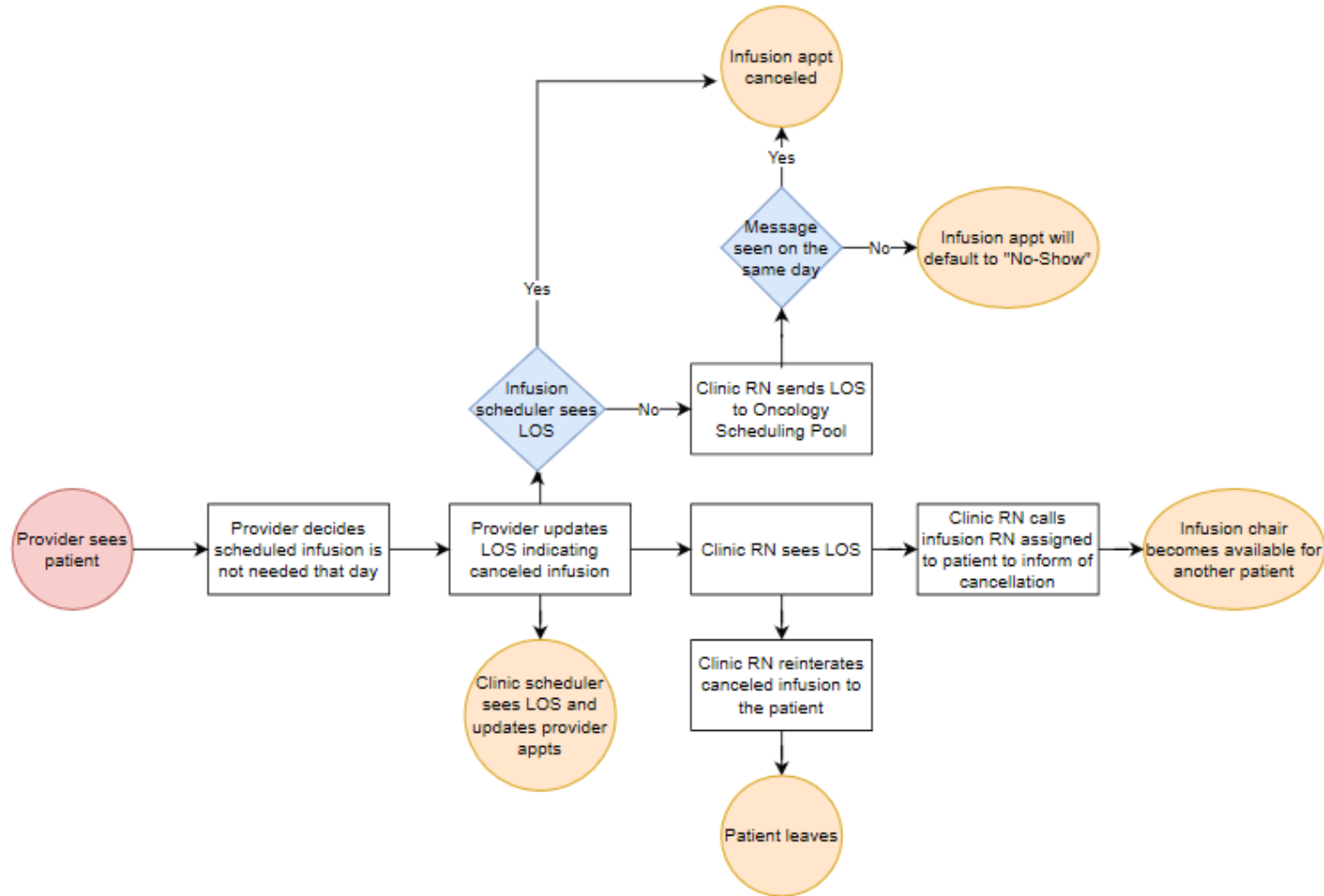

- Lack of communication between clinic and infusion center

Process Map 3: No-Show Follow-Up

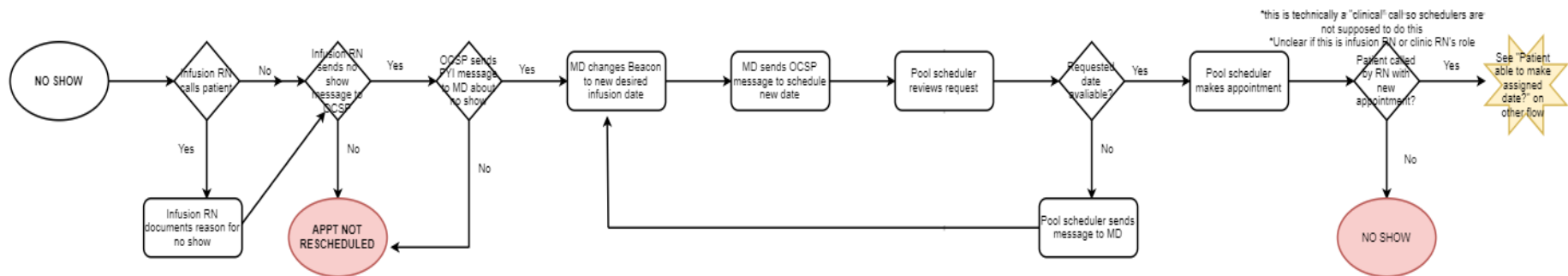

- No standard process to inform patients of changes
- Reliance on “pools” to relay scheduling information
- Rescheduling decisions dependent on MD input

Cause and Effect diagram

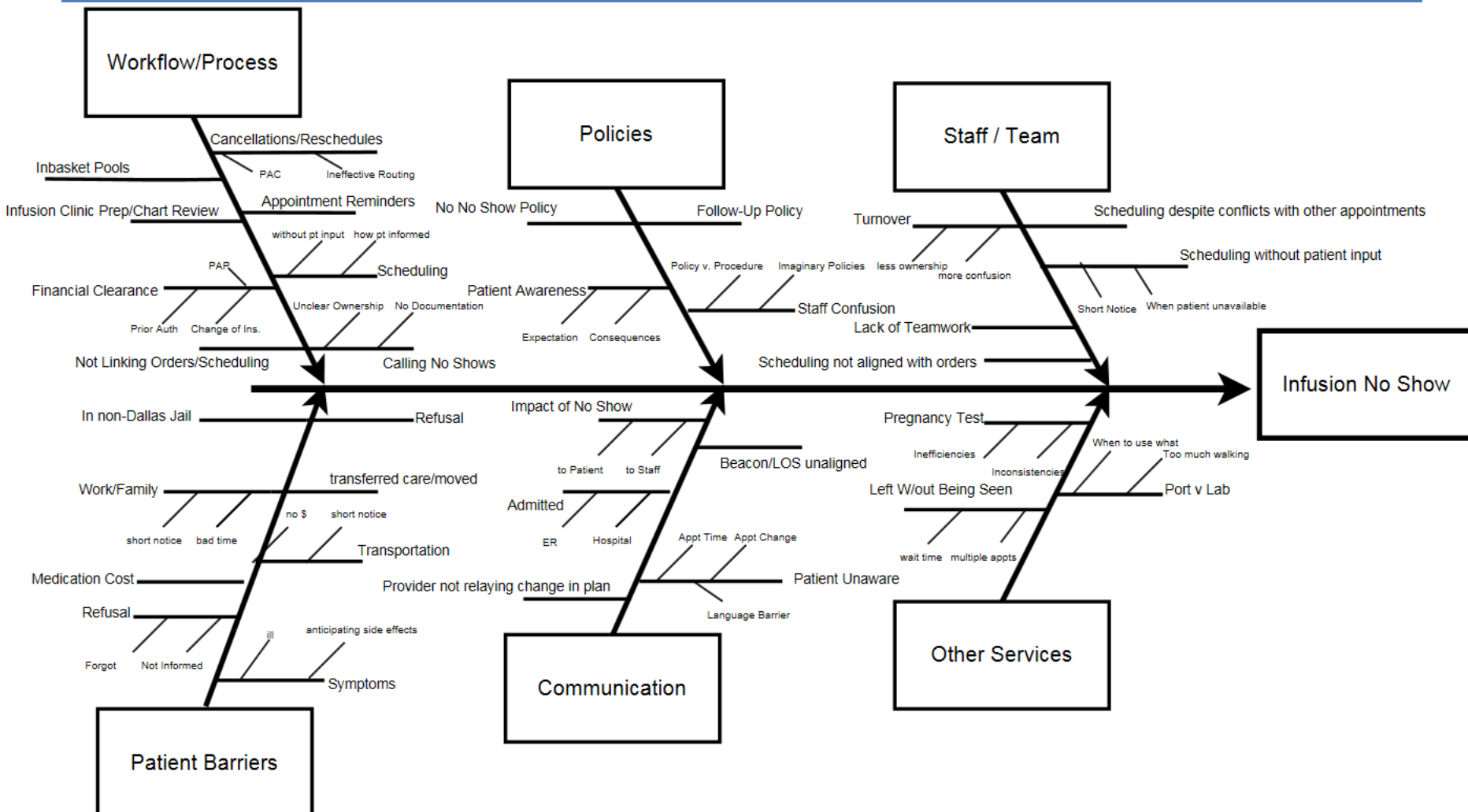

Cause and Effect diagram

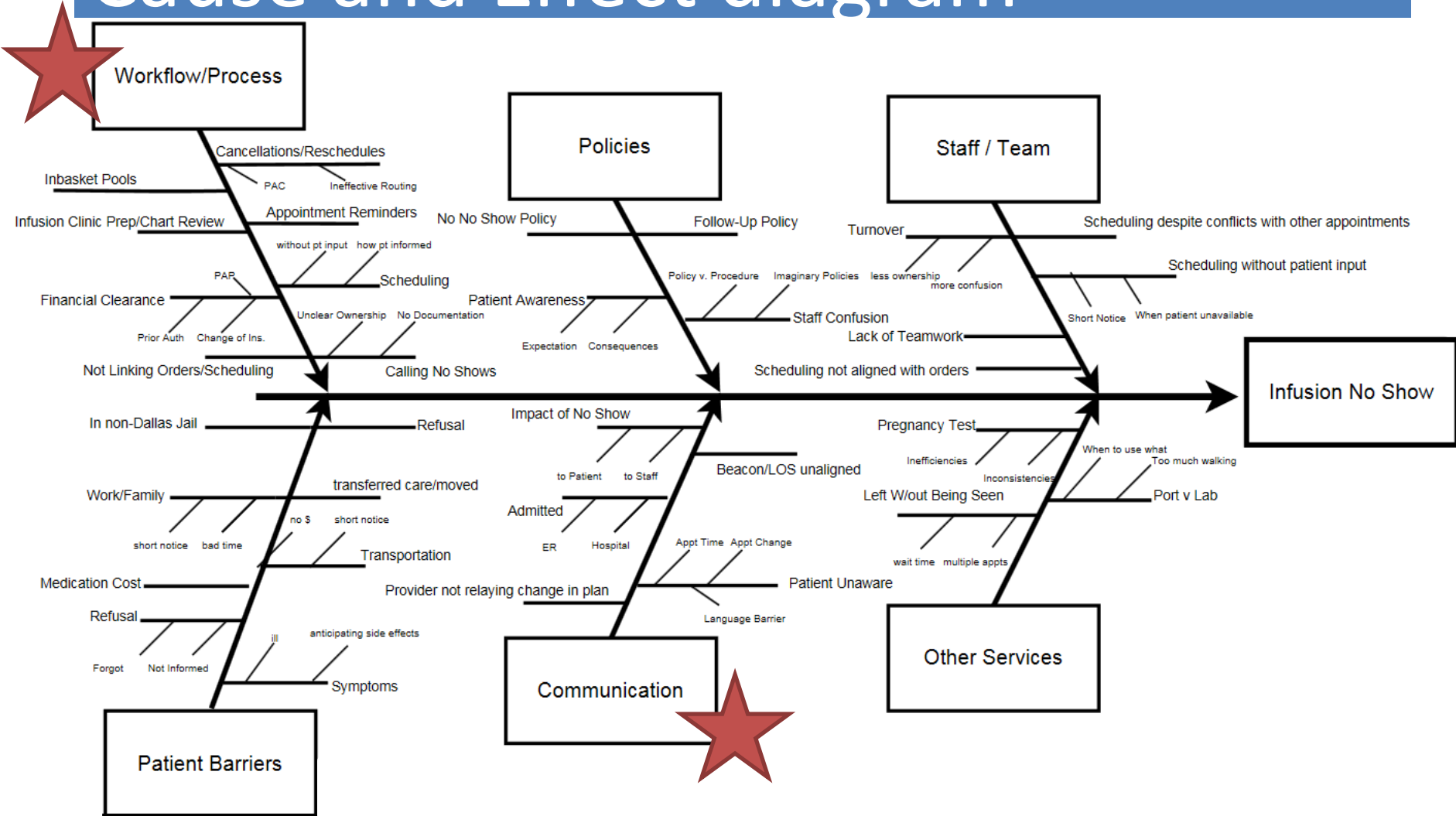

Diagnostic Data Summary

Item	Description
Measure:	Rate of patients with no-shows to infusion appointments who have documented follow-up
Patient population:	Patients who no-showed scheduled infusions or injections in the infusion center
Calculation methodology:	$\frac{\text{No showed patients with follow up documented}}{\text{Total \# of no showed patients}}$
Data source:	Manual EPIC chart review of patients who no-showed oncology infusion center appointments January through June 2020
Data collection frequency:	Weekly
Data limitations:	Time spent in manual chart review, inconsistent methods of documentation in chart

Countermeasures

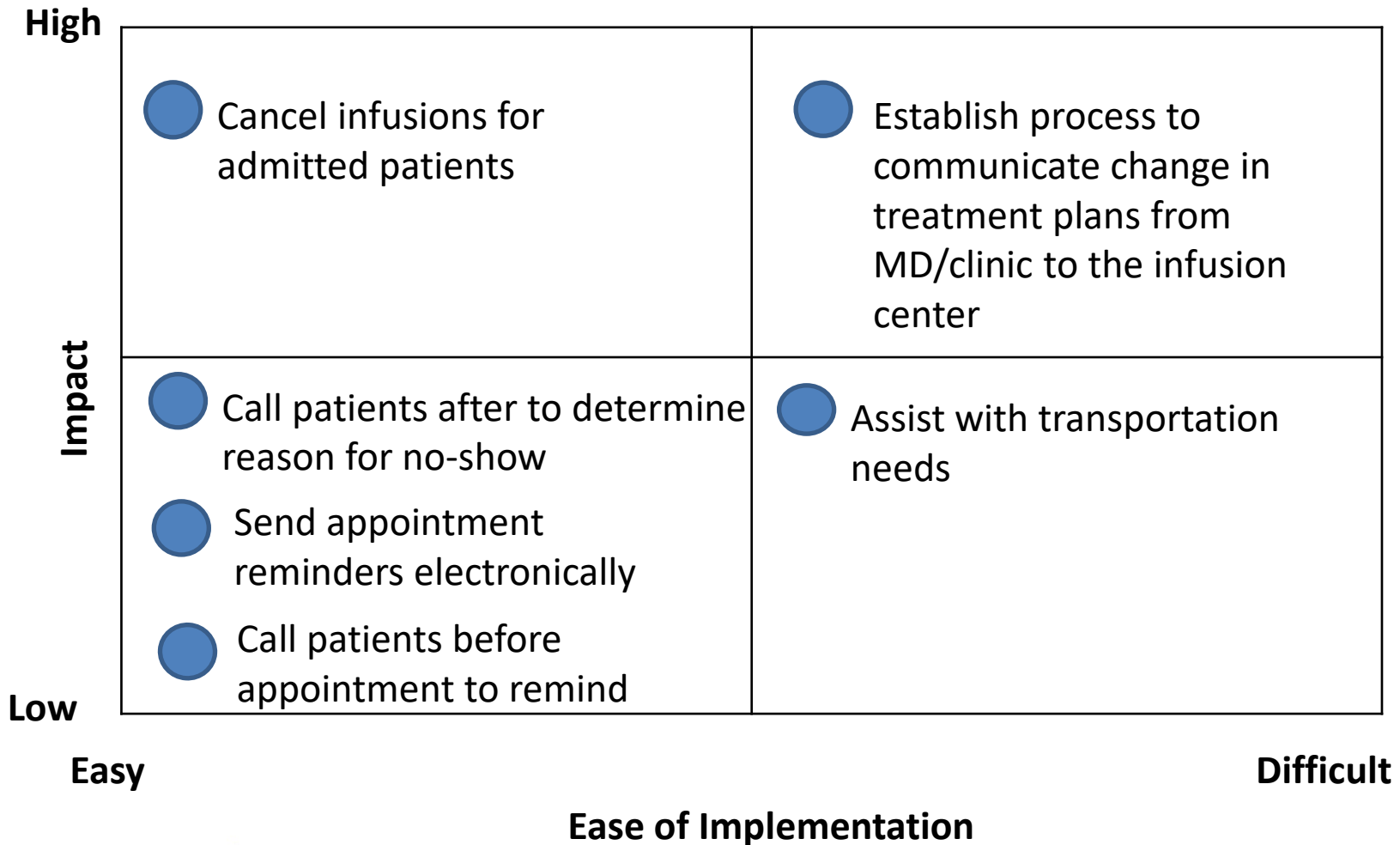

Countermeasures

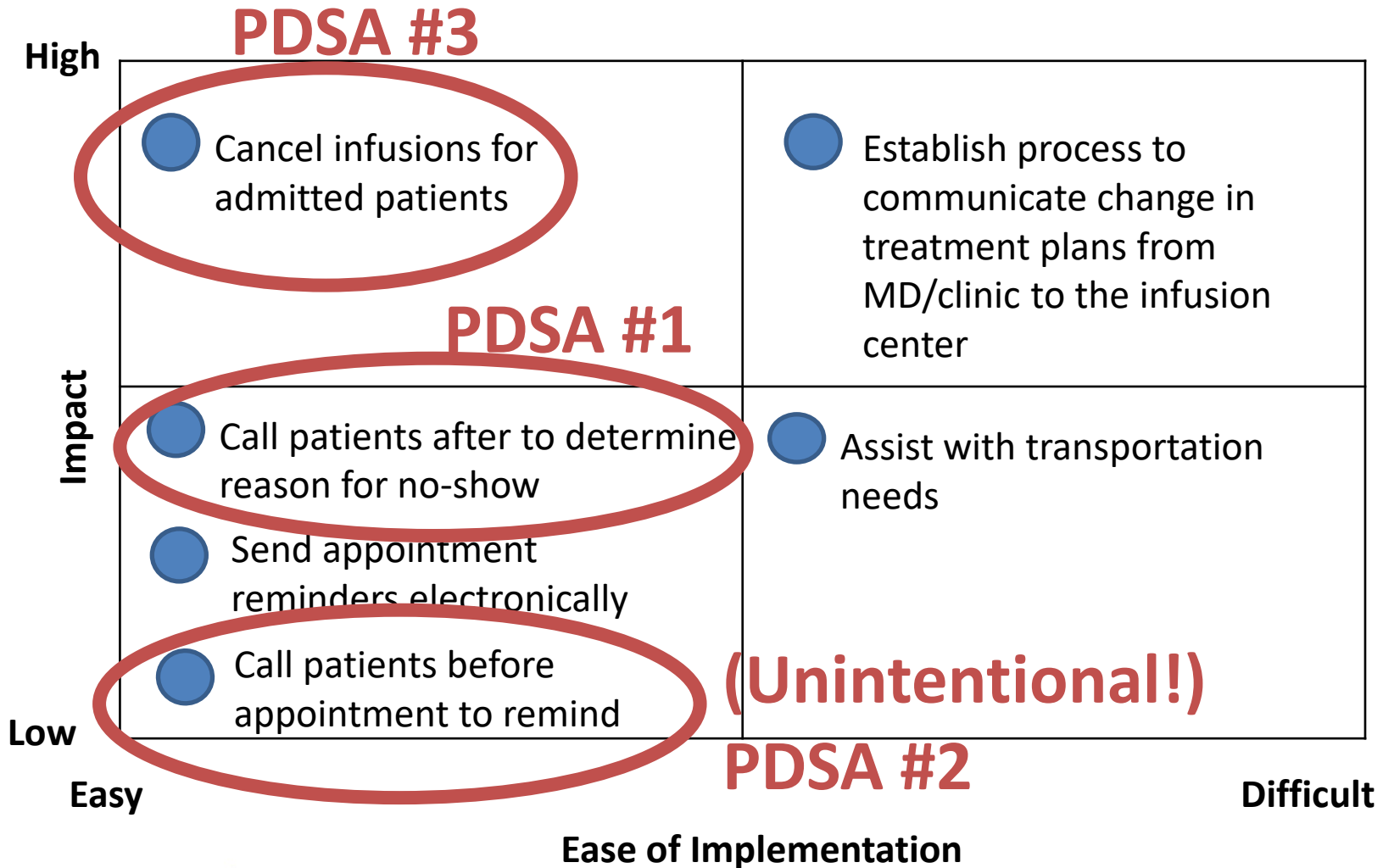

Test of Change

PDSA Plan

Date	PDSA Description	Result
02/10/2020-03/23/2020	Call patients who no-show, document reason for no-show, route documentation to provider	-NSR 14.4% - 13% improvement over baseline -Able to use information to plan future interventions
04/01/2020-07/31/2020	Call patients 24-72 hrs prior to scheduled infusion as part of a mandatory COVID screening process.	-NSR: 11.5% -30% improvement over baseline
08/17/2020-08/28/2020	Automatically cancel infusion appointments for patients who are admitted on the day of their appointment. Provider notified in order to reschedule.	-NSR: 10.9% -34% improvement over baseline -Limited time frame of cycle

Outcome Measure Change Data

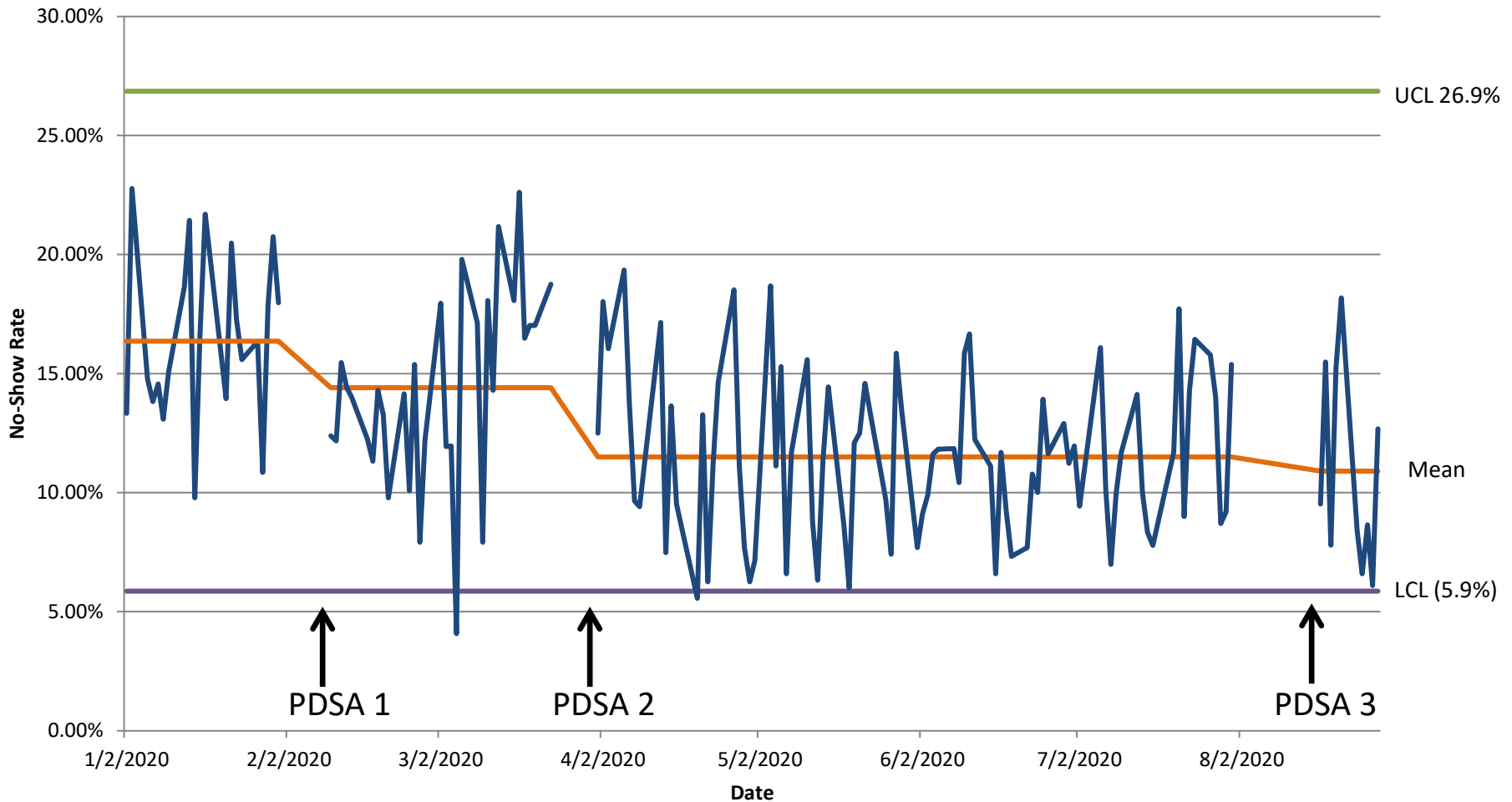

Next steps

Sustainability Plan

Next Steps	Owner
Monitor PDSA cycle 3 for another 1-2 months to determine if a significant decrease in no-show rate is achieved	Bryana Anderson
Make permanent the process to cancel appointments of admitted patients	Charles Okpara
Implement automatic data collection algorithm	Bryana Anderson and Umber Dickerson
Simplify scheduling template to 1 infusion center	Umber Dickerson and team
Implement standardized no-show follow up process based on our initial intervention	Umber Dickerson and team
Leverage new care teams and assigned schedulers to address no-shows that are related to changes in clinic plans	Umber Dickerson, Amy Jones, Radhika Kainthla

Conclusion

- We were able to lower our infusion no-show rate by 34% over a 6 month period by:
 - Calling patients before and after appointments
 - Automatically canceling appointments of admitted patients
- Patient reasons for no show were most difficult to address but actually not the most common reasons for no show
- Able to bring to light major issues with intra-clinic communication
 - Redefining personnel roles and standard processes
 - New hires
 - Communication with patient
- COVID-19 pandemic unintentionally helped our project